

Argenta

■ WALL MOUNTING METAL CABINETS

The ARGENTA Series is a group of metal enclosures used to house on the inside electrical or electronic switchgear, controlgear and equipment necessary to supply and distribute electricity.

Mainly meant for industrial electrical installations as enclosures for measurement, transmission, signposting control equipment or enclosures for all the equipment necessary to coordinate the different electrical currents. The ARGENTA is made up of a wide range of standard models, manufactured in opaque and transparent door version.

The design and manufacture of this product line is flexible enough so as to adapt to special executions that require specific dimensions in agreement with user and installation requirements. Enclosures made with high quality materials in cold-rolled steel plate of up to 2 mm thick and coated with RAL 7035 hardened epoxy-polyester paint.

This series is completed with a set of accessories like mounting plates, inner doors, canopies, elevation eyebolts, ventilation systems, etc.



cULus
LISTED
FILE: E306947

TECHNICAL DATA

■ degree of protection	IP66*
■ resistance to impact	IK10
■ range of temperature under normal conditions	-25°C/+40°C
■ maximum operation voltage (Ue)	1000 V

According to 2006/95/CE directive; and UL 508A, UNE-EN 62208.

The technical features described above are achieved using the components and the accessories supplied by IDE, mounted and assembled according to the corresponding technical guidelines and instruction sheets.

**Except double door cabinets (IP55)*

technical FEATURES



PRODUCT RANGE

Dimensions available:

- Height: from 250 to 1.400 mm
- Width: from 200 to 1.200 mm
- Depth: from 150 to 400 mm

For cabinets of width 1.000 and 1.200 mm, a single or double door is available

CASE

Double fold to prevent water from entering the inside of the cabinet



Bolts placed in the cabinet case and in the door, allowing the link by earth and guaranteeing connectivity between door and base of cabinet



Watertightness gasket to ensure the IP66 protection degree

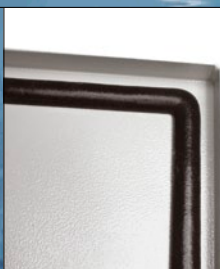

DOORS

110° door opening



Easy to assemble bolt with anti-lost system



Reinforcement profiles for opaque doors permitting the assembly of devices to the door. 25 mm separation between the holes



Centring device included inside the cabinets of 1000 mm and 1200 mm. This piece avoids eventual deviations caused by the weight of the electrical elements included inside the cabinets



technical FEATURES

Blind and grooved mounting plates. 14x9 holes to insert cage nuts and devices or other accessories without having to remove the cabinet plate

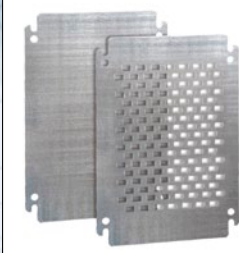

ACCESSORIES

Height adjustment element for the mounting plate. The height can be adjusted every 12,5 mm



Possibility of incorporating an inner door. It is supplied with the same type of lock as the outer door, reversible hinges and 90° opening



Modular chassis for 150 and 200 mm depth cabinets, with capacity from 16 to 128 modules



Canopy that protects the light indicators or controls from the rain and dust



200 mm plinth supplied like accessory



ACCESSORIES

Door supplied with one or two locks depending on the size of the cabinet. For large-sized cabinets it is supplied with a three-point lock



Plinth cable support



High-quality lock. Four types of locks are supplied as accessories, for different uses, triangle, square, 1/4 turning lock-key, and 1/4 turning lock with wing nut



Lifting eyebolts, placed on the top of the cabinet to transport easily very heavy units



Possibility of fastening directly to the wall or using outside flanges, guaranteeing the IP protection degree



Mast mounting kit. Minimum diameter 60 mm, maximum diameter 200 mm, maximum weight 130 kg



Inner attachment support, to screw the hooks from the outside of the cabinet



CUSTOMIZED solutions

A DIFFERENT DESIGN TO SUIT ALL TYPES OF NEEDS

IDE offers the possibility of making metal enclosures which adapt to each installation. Its versatile manufacturing process allows producing any type of cabinet at very competitive prices and with very short lead times.

Sizes, shapes, drillings, colours, made with high quality materials that satisfy the technical and quality demand for the market.

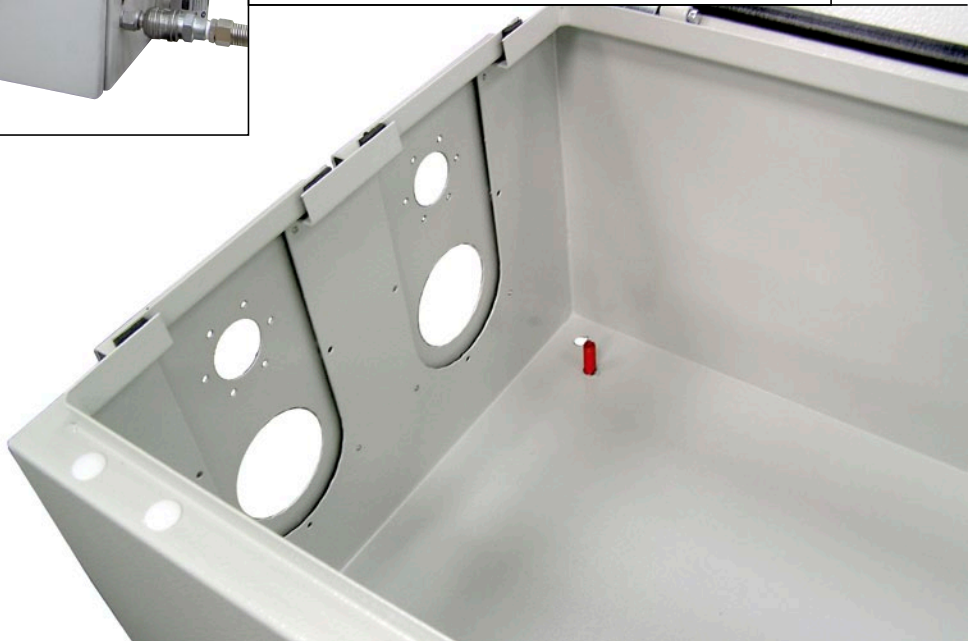

■ CUT-OUTS

Cut-outs in case, door, mounting plate or cable gland lid, according to the needs of the installation



Possibility of making any size and shape cut-out: round, square, hexagonal...

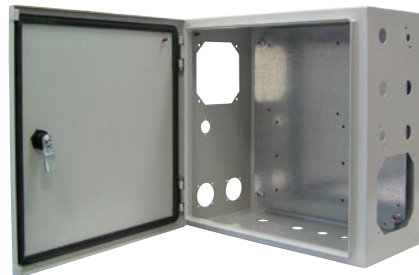

■ COLOURS

Possibility of painting the cabinets in any colour of the RAL chart (check minimum quantities and delivery times)



The intellectual property of the design and drawings of the special cabinets belongs integrally to the customer who requested them. IDE has the obligation to maintain secrecy in this regard.

WALL MOUNTING METAL CABINETS

(WITH BLIND PLATE INCLUDED)



Commercial Ref.	Dimensions (mm) (A x B x C)	Cable entries (D x E)	Locks number	Hinges number
GN252015	250 x 200 x 150	80 x 150	1	2
GN252515	250 x 250 x 150	80 x 150	1	2
GN302015	300 x 200 x 150	80 x 150	1	2
GN302515	300 x 250 x 150	80 x 150	1	2
GN302520	300 x 250 x 200			
GN303015	300 x 300 x 150	80 x 200	1	2
GN303020	300 x 300 x 200	140 x 230		
GN304020	300 x 400 x 200	140 x 300		
GN403015	400 x 300 x 150	80 x 200		
GN403020	400 x 300 x 200	140 x 230		
GN404015	400 x 400 x 150	80 x 300	1	2
GN404020	400 x 400 x 200	140 x 300		
GN406020	400 x 600 x 200	140 x 500	1	2
GN406025	400 x 600 x 250			
GN406030	400 x 600 x 300			
GN503015	500 x 300 x 150	80 x 200	2	2
GN503020	500 x 300 x 200	140 x 230		
GN504015	500 x 400 x 150	80 x 300	2	2
GN504020	500 x 400 x 200	140 x 300		
GN504025	500 x 400 x 250			
GN505015	500 x 500 x 150	80 x 300	2	2
GN505020	500 x 500 x 200	140 x 400		
GN505025	500 x 500 x 250			
GN505030	500 x 500 x 300			
GN604015	600 x 400 x 150	80 x 300	2	2
GN604020	600 x 400 x 200	140 x 300		
GN604025	600 x 400 x 250			
GN604030	600 x 400 x 300			
GN605015	600 x 500 x 150	80 x 300	2	2
GN605020	600 x 500 x 200	140 x 400		
GN605025	600 x 500 x 250			
GN605030	600 x 500 x 300			
GN606020	600 x 600 x 200	140 x 500	2	2
GN606025	600 x 600 x 250			
GN606030	600 x 600 x 300			
GN608030	600 x 800 x 300	140 x 700	2	2
GN705015	700 x 500 x 150	80 x 300	2	2
GN705020	700 x 500 x 200	140 x 400		
GN705025	700 x 500 x 250			
GN804020	800 x 400 x 200	140 x 300	2	3
GN804025	800 x 400 x 250			
GN806020	800 x 600 x 200	140 x 500	2	3
GN806025	800 x 600 x 250			
GN806030	800 x 600 x 300			

For transparent doors,
please ask for prices and
delivery terms

Continues on next page



WALL MOUNTING METAL CABINETS (WITH BLIND PLATE INCLUDED)



Commercial Ref.	Dimensions (mm) (A x B x C)	Cable entries (D x E)	Locks number	Hinges number
GN808020	800 x 800 x 200	140 x 700	2	3
GN808025	800 x 800 x 250			
GN808030	800 x 800 x 300			
GN808040	800 x 800 x 400			
GN8010030	800 x 1.000 x 300	140 x 900	2	3
GN8010030/PD	800 x 1.000 x 300			
GN1006025	1.000 x 600 x 250	140 x 500	3P	3
GN1006030	1.000 x 600 x 300			
GN1006040	1.000 x 600 x 400			
GN1008025	1.000 x 800 x 250	140 x 700	3P	3
GN1008030	1.000 x 800 x 400			
GN1008040	1.000 x 800 x 300			
GN10010030	1.000 x 1.000 x 300	140 x 900	3P	3
GN10010030/PD	1.000 x 1.000 x 300			
GN10010040/PD	1.000 x 1.000 x 400			
GN1206025	1.200 x 600 x 250	140 x 500	3P	3
GN1206030	1.200 x 600 x 300			
GN1208030	1.200 x 800 x 300	140 x 700	3P	3
GN1208040	1.200 x 800 x 400			
GN1209030	1.200 x 900 x 285	140 x 700	3P	3
GN12010030	1.200 x 1.000 x 300	140 x 900	3P	3
GN12010030/PD	1.200 x 1.000 x 300			
GN12010040/PD	1.200 x 1.000 x 400			
GN12012025	1.200 x 1.200 x 250	2 x (140 x 500)	3P	3
GN14010030/PD	1.400 x 1.000 x 300	140 x 900	3P	3
GN14010040/PD	1.400 x 1.000 x 400			

For transparent doors,
please ask for prices and
delivery terms

/PD: IP55 Double-door Cabinet
3P: Three-point lock

DIMENSIONS

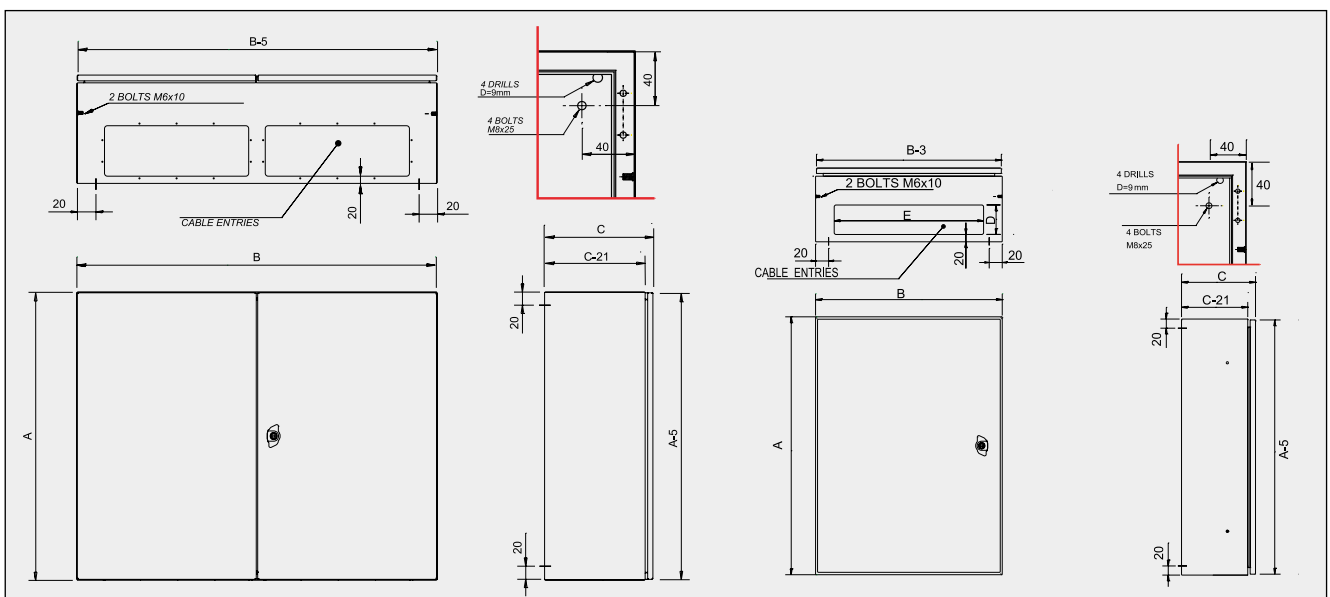

MODULAR CHASSIS



COMPONENTS:

- DIN rail frame, metal lid, locking screws and height adjuster (4 x chassis)

Commercial Ref.	Total modules	Rows	Cabinet Ref.
CH3025/1520	16	2x8	GN302515/GN302520
CH4030/1520	33	3x11	GN403015/GN403020
CH5040/1520	48	3x16	GN504015/GN504020
CH5040/2530	48	3x16	GN504025
CH6040/1520	64	4x16	GN604015/GN604020
CH6040/2530	64	4x16	GN604025/GN604030
CH6060/1250	104	4x26	GN606020
CH6060/2530	104	4x26	GN606025/GN606030
CH7050/1520	110	5x22	GN705015/GN705020
CH7050/2530	110	5x22	GN705025
CH8060/1520	128	4x26 - 1x24	GN806020
CH8060/2530	128	4x26 - 1x24	GN806025/GN806030
CH8080/1520	190	5x38	GN808020
CH8080/2530	190	5x38	GN808025/GN808030

CABLE INPUT LID



Commercial Ref.	Dimensions (Width x Depth)	No. of flanges
TF0820	80x200	1
TF0830	80x300	1
TF1423	140x230	1
TF1430	140x300	1
TF1440	140x400	1
TF1450	140x500	2
TF1470	140x700	3
TF1490	140x900	3

PLINTH



200 PLINTH

Commercial Ref.	Dimensions
200 PLINTH	
	Width x Depth
ZCLA206025	600x250
ZCLA206030	600x300
ZCLA206040	600x400
ZCLA208025	800x250
ZCLA208030	800x300
ZCLA208040	800x400
ZCLA2010030	1.000x300
ZCLA2010040	1.000x400
ZCLA2012025	1.200x250

PLINTH CABLE SUPPORT

Commercial Ref.	
48497	Plinth cable support, 250 mm
48498	Plinth cable support, 300 mm
48499	Plinth cable support, 400 mm



BLIND PLATE ■

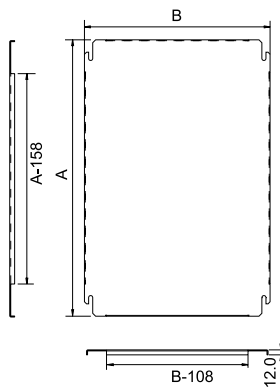

Commercial Ref.	Dimensions (mm) (A x B)	Cabinet Ref.
PL2520	220 x 150	GN252015
PL2525	220 x 200	GN252515
PL3020	270 x 150	GN302015
PL3025	270 x 200	GN302515 / GN302520
PL3030	270 x 250	GN303015 / GN303020
PL3040	270 x 350	GN304020
PL4030	370 x 250	GN403015 / GN403020
PL4040	370 x 350	GN404015 / GN404020
PL4060	370 x 550	GN406020 / GN406025 GN406030
PL5030	470 x 250	GN503015 / GN503020
PL5040	470 x 350	GN504015 / GN504020 GN504025
PL5050	470 x 450	GN505015 / GN505020 GN505025 / GN505030
PL6040	570 x 350	GN604015 / GN604020 GN604025 / GN604030
PL6050	570 x 450	GN605015 / GN605020 GN605025 / GN605030
PL6060	570 x 550	GN606020 / GN606025 GN606030
PL6080	570 x 750	GN608030
PL7050	670 x 450	GN705015 / GN705020 GN705025
PL8040	770 x 350	GN804020 / GN804025
PL8060	770 x 550	GN806020 / GN806025 GN806030
PL8080	770 x 750	GN808020 / GN808025 GN808030 / GN808040
PL80100	770 x 950	GN8010030
PL10060	970 x 550	GN1006025 / GN1006030 GN1006040
PL10080	970 x 750	GN1008025 / GN1008030 GN1008040
PL100100	970 x 950	GN10010030 / GN10010040
PL12060	1.170 x 550	GN1206025 / GN1206030
PL12080	1.170 x 750	GN1208030 / GN1208040
PL12090	1.170 x 850	GN1209030
PL120100	1.170 x 950	GN12010030 / GN12010040
PL120120	1.170 x 1.150	GN12012025
PL140100	1.370 x 950	GN14010030 / GN14010040

ACCESSORIES

48228

4 height adjusters + 4 anti rotation nuts bag

■ BAKELITE PLATE



Commercial Ref.	Dimensions (mm) (A x B)	Cabinet Ref.
PLB2520	220 x 150	GN252015
PLB2525	220 x 200	GN252515
PLB3020	270 x 150	GN302015
PLB3025	270 x 200	GN302515 / GN302520
PLB3030	270 x 250	GN303015 / GN303020
PLB3040	270 x 350	GN304020
PLB4030	370 x 250	GN403015 / GN403020
PLB4040	370 x 350	GN404015 / GN404020
PLB4060	370 x 550	GN406020 / GN406025 GN406030
PLB5030	470 x 250	GN503015 / GN503020
PLB5040	470 x 350	GN504015 / GN504020 GN504025
PLB5050	470 x 450	GN505015 / GN505020 GN505025 / GN505030
PLB6040	570 x 350	GN604015 / GN604020 GN604025 / GN604030
PLB6050	570 x 450	GN605015 / GN605020 GN605025 / GN605030
PLB6060	570 x 550	GN606020 / GN606025 GN606030
PLB6080	570 x 750	GN608030
PLB7050	670 x 450	GN705015 / GN705020 GN705025
PLB8040	770 x 350	GN804020 / GN804025
PLB8060	770 x 550	GN806020 / GN806025 GN806030
PLB8080	770 x 750	GN808020 / GN808025 GN808030 / GN808040
PLB80100	770 x 950	GN8010030
PLB10060	970 x 550	GN1006025 / GN1006030 GN1006040
PLB10080	970 x 750	GN1008025 / GN1008030 GN1008040
PLB100100	970 x 950	GN10010030 / GN10010040
PLB12060	1.170 x 550	GN1206025 / GN1206030
PLB12080	1.170 x 750	GN1208030 / GN1208040
PLB12090	1.170 x 850	GN1209030
PLB120100	1.170 x 950	GN12010030 / GN12010040
PLB120120	1.170 x 1.150	GN12012025
PLB140100	1.370 x 1.150	GN14010030 / GN14010040

ACCESSORIES

48228

4 height adjusters + 4 anti rotation nuts bag

GROOVED PLATE ■

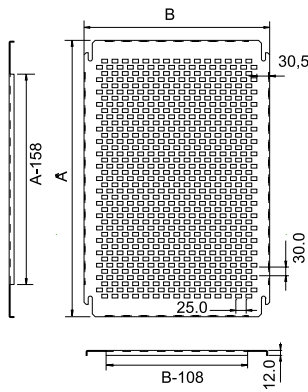
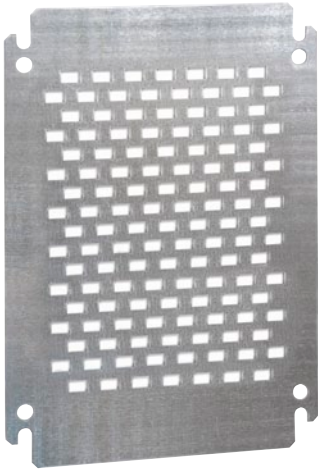

Commercial Ref.	Dimensions (mm) (A x B)	Cabinet Ref.
PLU2520	220 x 150	GN252015
PLU2525	220 x 200	GN252515
PLU3020	270 x 150	GN302015
PLU3025	270 x 200	GN302515 / GN302520
PLU3030	270 x 250	GN303015 / GN303020
PLU3040	270 x 350	GN304020
PLU4030	370 x 250	GN403015 / GN403020
PLU4040	370 x 350	GN404015 / GN404020
PLU4060	400 x 550	GN406020 / GN406025 GN406030
PLU5030	470 x 250	GN503015 / GN503020
PLU5040	470 x 350	GN504015 / GN504020 GN504025
PLU5050	470 x 450	GN505015 / GN505020 GN505025 / GN505030
PLU6040	570 x 350	GN604015 / GN604020 GN604025 / GN604030
PLU6050	570 x 450	GN605015 / GN605020 GN605025 / GN605030
PLU6060	570 x 550	GN606020 / GN606025 GN606030
PLU6080	570 x 750	GN608030
PLU7050	670 x 450	GN705015 / GN705020 GN705025
PLU8040	770 x 350	GN804020 / GN804025
PLU8060	770 x 550	GN806020 / GN806025 GN806030
PLU8080	770 x 750	GN808020 / GN808025 GN808030 / GN808040
PLU80100	770 x 950	GN8010030
PLU10060	970 x 550	GN1006025 / GN1006030 GN1006040
PLU10080	970 x 750	GN1008025 / GN1008030 GN1008040
PLU100100	970 x 950	GN10010030 / GN10010040
PLU12060	1.170 x 550	GN1206025 / GN1206030
PLU12080	1.170 x 750	GN1208030 / GN1208040
PLU12090	1.170 x 850	GN1209030
PLU120100	1.170 x 950	GN12010030 / GN12010040
PLU120120	1.170 x 1.150	GN12012025

ACCESSORIES

48228

4 height adjusters + 4 anti rotation nuts bag

■ INNER DOOR



Commercial Ref.	Dimensions (mm) (Height x Depth)	Cabinet Ref.
PIN3020	250 x 150	GN302015
PIN3025	250 x 200	GN302515 / GN302520
PIN3030	250 x 250	GN303015 / GN303020
PIN3040	250 x 350	GN304020
PIN4030	350 x 250	GN403015 / GN403020
PIN4040	350 x 350	GN404015 / GN404020
PIN4060	350 x 550	GN406020 / GN406025 GN406030
PIN5030	450 x 250	GN503015 / GN503020
PIN5040	450 x 350	GN504015 / GN504020 GN504025
PIN5050	450 x 450	GN505015 / GN505020 GN505025 / GN505030
PIN6040	550 x 350	GN604015 / GN604020 GN604025 / GN604030
PIN6050	550 x 450	GN605015 / GN605020 GN605025 / GN605030
PIN6060	550 x 550	GN606020 / GN606025 GN606030
PIN6080	550 x 750	GN608030
PIN7050	650 x 450	GN705015 / GN705020 GN705025
PIN8040	750 x 350	GN804020 / GN804025
PIN8060	750 x 550	GN806020 / GN806025 GN806030
PIN8080	750 x 750	GN808020 / GN808025 GN808030 / GN808040
PIN80100	750 x 950	GN8010030
PIN10060	950 x 550	GN1006025 / GN1006030 GN1006040
PIN10080	950 x 550	GN1008025 / GN1008030 GN1008040
PIN100100	950 x 950	GN10010030 / GN10010040
PIN12060	1.150 x 550	GN1206025 / GN1206030
PIN12080	1.150 x 750	GN1208030 / GN1208040
PIN12090	1.150 x 850	GN1209030
PIN120100	1.150 x 950	GN12010030 / GN12010040
PIN120120	1.150 x 1.150	GN12012025
PIN140100	1.350 x 950	GN14010030 / GN14010040

In order to achieve the correct assembly of the INNER DOOR is necessary to request the Height Adjustment Element. (see next page)

HEIGHT ADJUSTMENT ELEMENTS ■

	Commercial Ref.		Cabinet depth (mm)
	SP150	150	Height adjustment element kit (4 pcs.)
SP200	200	Height adjustment element kit (4 pcs.)	
SP250	250	Height adjustment element kit (4 pcs.)	
SP285	285	Height adjustment element kit (4 pcs.)	
SP300	300	Height adjustment element kit (4 pcs.)	
SP400	400	Height adjustment element kit (4 pcs.)	

WALL MOUNTING SUPPORT ■

	Commercial Ref.	
	48423	Wall mounting support 20x20 (4 pcs.)

INNER ATTACHMENT SUPPORT ■

	Commercial Ref.	
	48422	Inner hook fitting (4 pcs.)

CABINET LIFTING EYEBOLTS ■

	Commercial Ref.	
	48475	Cabinet lifting eyebolts (2 pcs.)

MAST ATTACHMENT PACK ■

	Commercial Ref.	
	48420	Mast attachment pack (2 pcs.)

■ SPARE DOORS







Ref.	Dimensions (mm)	Ref.	Dimensions (mm)	Ref.	Dimensions (mm)
PO2520	250 x 200	PO5050	500 x 500	PO10060	1.000 x 600
PO2525	250 x 250	PO6040	600 x 400	PO10080	1.000 x 800
PO3020	300 x 200	PO6050	600 x 500	PO100100	1.000 x 1.000
PO3025	300 x 250	PO6060	600 x 600	PO100100/PD	1.000 x 1.000
PO3030	300 x 300	PO6080	600 x 800	PO12060	1.200 x 600
PO3040	300 x 400	PO7050	700 x 500	PO12080	1.200 x 800
PO4030	400 x 300	PO8040	800 x 400	PO12090	1.200 x 900
PO4040	400 x 400	PO8060	800 x 600	PO120100	1.200 x 1.000
PO4060	400 x 600	PO8080	800 x 800	PO120100/PD	1.200 x 1.000
PO5030	500 x 300	PO80100	800 x 1.000	PO120120	1.200 x 1.200
PO5040	500 x 400	PO80100/PD	800 x 1.000	PO140100/PD	1.400 x 1.000

/PD: Opaque double doors (500+500)
Supplied without lock.

■ DOOR ASSEMBLY PROFILES

	Commercial Ref.	
	PMP300	Assembly profile for door, width 300
PMP400	Assembly profile for door, width 400	
PMP500	Assembly profile for door, width 500	
PMP600	Assembly profile for door, width 600	
PMP800	Assembly profile for door, width 800	
PMP900	Assembly profile for door, width 900	
PMP1000	Assembly profile for door, width 1.000	
PMP1200	Assembly profile for door, width 1.200	

■ LOCKS

	Ref.			Ref.			
	48450	5 mm double-bit lock		48495	1/4 turning lock with key F-124E type		
		48451		Lock in triangle with key		48496	1/4 turning lock with three-point and key
				48455		Lock in square with key	
			48456	1/4 turning lock with key			
	48493	1/4 turning lock with key F-405 type					
	48494	1/4 turning lock with key F-455 type					
	48495	1/4 turning lock with key F-124E type					
	48496	1/4 turning lock with three-point and key					

CANOPY ■



Commercial Ref.	Dimensions (mm) (Width x Depth)	Cabinet Ref.
TEJ2015	210 x 174	GN252015 / GN302015
TEJ2515	260 x 174	GN252515 / GN302515
TEJ2520	260 x 224	GN302520
TEJ3015	310 x 174	GN303015 / GN403015 GN503015
TEJ3020	310 x 224	GN303020 / GN403020 GN503020
TEJ4015	410 x 174	GN404015 / GN504015 GN604015
TEJ4020	410 x 224	GN304020 / GN404020 GN504020 / GN604020 GN804020
TEJ4025	410 x 274	GN504025 / GN604025 GN804025
TEJ4030	410 x 324	GN604030
TEJ5015	510 x 174	GN505015 / GN605015 GN705015
TEJ5020	510 x 224	GN505020 / GN605020 GN705020
TEJ5025	510 x 274	GN505025 / GN605025 GN705025
TEJ5030	510 x 324	GN505030 / GN605030
TEJ6020	610 x 224	GN406020 / GN606020 GN806020
TEJ6025	610 x 274	GN406025 / GN606025 GN806025 / GN1006025 GN1206025
TEJ6030	610 x 324	GN406030 / GN606030 GN806030 / GN1006030 GN1206030
TEJ8020	810 x 224	GN808020
TEJ8025	810 x 274	GN808025 / GN1008025
TEJ8030	810 x 324	GN608030 / GN808030 GN1008030 / GN1208030
TEJ9030	910 x 309	GN1209030
TEJ10030	1.010 x 324	GN8010030 / GN10010030 GN12010030 / GN14010030
TEJ10040	1.100 x 424	GN10010040 / GN12010040 GN14010040
TEJ12025	1.210 x 274	GN12012025